

# XCR70\_E越野轮胎起重机 / Rough Terrain Crane

## 技术规格书

Technical specifications



70t



45m

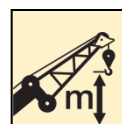

57.9m



2021年10月 第4版

# 目录

## Contents

### 目录

#### Contents

|                                               |       |
|-----------------------------------------------|-------|
| 尺寸参数<br>Dimensions                            | 3     |
| 技术规格<br>Technical specifications              | 4-5   |
| 重量/作业速度<br>Weight / Working speeds            | 6     |
| 平衡重<br>Counterweight                          | 7     |
| 臂架组合方案<br>Boom / Jib combinations             | 8-9   |
| 主臂<br>Boom                                    | 10-12 |
| 副臂<br>Jib                                     | 13-15 |
| 符号标识<br>Description of symbols                | 16    |
| 主要技术参数表<br>Table of main technical parameters | 17-18 |
| 注意事项<br>Notes                                 | 19    |

# 尺寸参数 Dimensions

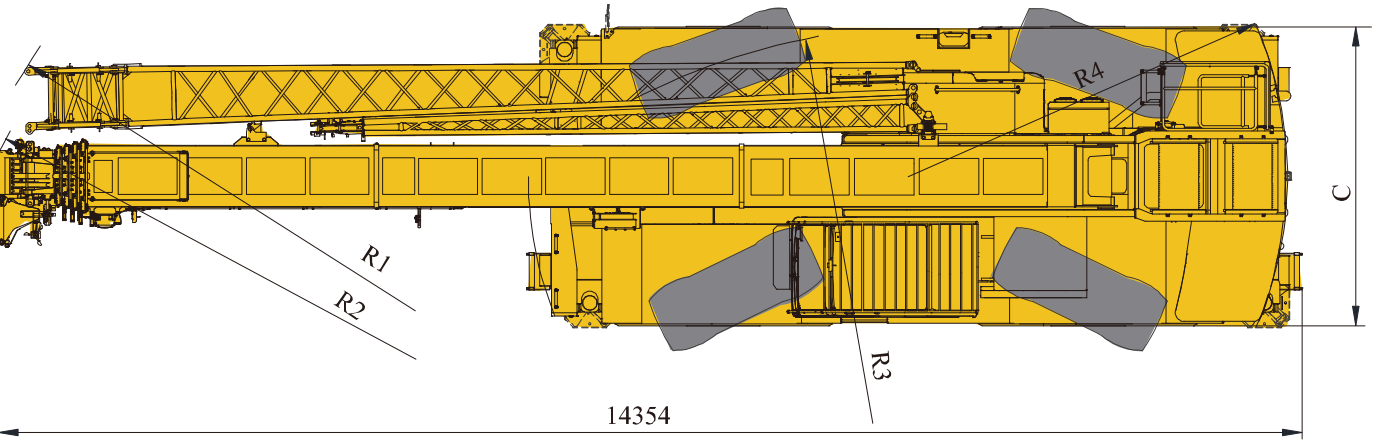
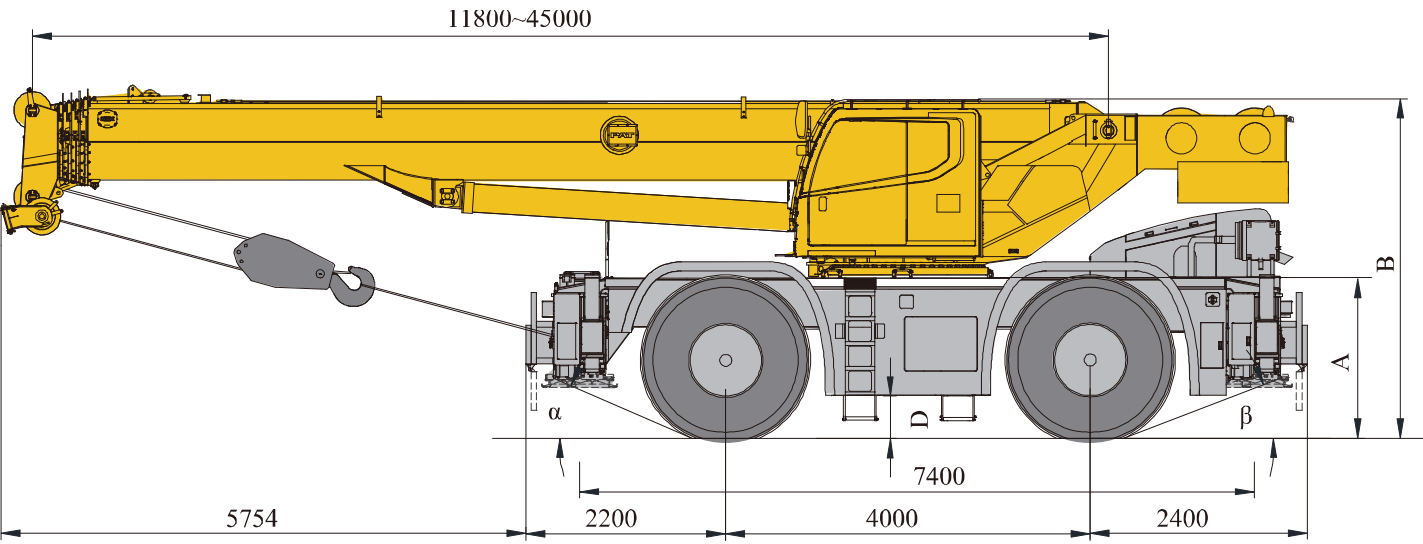

|         | $\alpha$ | $\beta$ | A    | B    | C    | D   | R1    | R2    | R3   | R4   |
|---------|----------|---------|------|------|------|-----|-------|-------|------|------|
| 29.5R25 | 23°      | 21°     | 1766 | 3750 | 3290 | 475 | 11445 | 11247 | 6500 | 4200 |

# 技术规格

## Technical specifications

|  |                                                                                                                                                                                                               | 配置     |
|----------------------------------------------------------------------------------|---------------------------------------------------------------------------------------------------------------------------------------------------------------------------------------------------------------|--------|
| <b>主臂</b>                                                                        | 1节基本臂和4节伸缩臂，U形截面的焊接结构，双缸绳排伸缩机构。臂头标配6个滑轮。<br>主臂长度：11.8m~45m。                                                                                                                                                   | ●      |
| <b>副臂</b>                                                                        | 2节，桁架式结构，0°、15°和30°三种安装角度，安装在主臂侧面。<br>副臂长度：9.2m~16m。                                                                                                                                                          | ●      |
| <b>车架</b>                                                                        | 车架采用细晶粒高强度钢焊接而成，抗扭转大截面框架结构，承载能力强。                                                                                                                                                                             | ●      |
| <b>支腿</b>                                                                        | 4支腿，H型布置，位于车架两端，由电控液压控制。                                                                                                                                                                                      | ●      |
| <b>发动机</b>                                                                       | 美国康明斯制造，直列六缸、水冷压燃式柴油发动机，<br>QSB6.7：额定功率 194/2200(kW/(r/min))，最大扭矩 990/1500(N.m/(r/min))<br>EU Stage IV排放标准<br>B6.7：额定功率209/2000(kW/(r/min))<br>最大扭矩1152/1500(N.m/(r/min))<br>EU Stage V排放标准<br>燃油箱有效容积：约305L。 | ●      |
| <b>变速箱</b>                                                                       | 6WG210，德国ZF自动变速箱，6个前进档，3个倒档。                                                                                                                                                                                  | ●      |
| <b>车桥</b>                                                                        | 前后桥均为转向驱动桥，承载能力大。                                                                                                                                                                                             | ●      |
| <b>悬挂</b>                                                                        | 前桥与车架刚性连接；<br>后桥采用摆动式液压悬架，公路行驶具有减震功能，缓冲路面冲击；吊重行驶时后悬架油缸锁止至刚性状态，增加作业稳定性。                                                                                                                                        | ●      |
| <b>轮胎</b>                                                                        | 4个专用越野轮胎，每桥均装单胎，承载能力大。<br>轮胎规格：29.5R25。                                                                                                                                                                       | ●      |
| <b>转向</b>                                                                        | 具有前桥独立转向、小转弯转向、蟹行转向和后桥独立四种转向功能。模式切换时可实现转角自调整。                                                                                                                                                                 | ●      |
| <b>制动</b>                                                                        | 行车制动：双回路全液压盘式制动，作用于所有车轮；当系统压力过低时，具有自动报警、自动制动功能。<br>驻车制动：弹簧加载、液压解除的独立盘式制动器，作用于前桥。                                                                                                                              | ●      |
| <b>液压系统</b>                                                                      | 双变量柱塞泵用于起升、变幅、伸缩，齿轮泵用于回转、支腿、转向、制动等动作；主阀采用负载敏感式比例多路换向阀；配置独立的液压油散热器；<br>液压油箱容积：约1120L。                                                                                                                          | ●      |
| <b>操纵方式</b>                                                                      | 液控先导操纵系统，由左右2个操纵手柄控制起重机的主要动作。                                                                                                                                                                                 | ●      |
| <b>电气系统</b>                                                                      | 直流24伏特，2块12伏电瓶串联。<br>配有力矩限制器和前照灯、转向灯、倒车灯、转台工作灯、吊臂工作灯、回转警示灯等。                                                                                                                                                  | ●      |
| <b>主、副起升机构</b>                                                                   | 由液压马达通过行星齿轮减速器驱动，内置常闭式制动器并带有平衡阀。                                                                                                                                                                              | ●      |
| <b>回转机构</b>                                                                      | 单排四点接触球式回转支承，液压马达驱动内置行星齿轮减速器，减速机配备常闭式制动器。                                                                                                                                                                     | ●      |
| <b>司机室</b>                                                                       | 翻转式司机室，滑移式车门，可调式座椅，装有安全玻璃、顶部保护栏，前风窗及顶部装有遮阳帘。<br>配置冷暖空调、收音机、12V和24V电源接口。                                                                                                                                       | ●      |
| <b>安全装置</b>                                                                      | 配有液压平衡阀、溢流阀、双向锁、LMI；三圈保护器，防止钢丝绳过放；臂头设置高度限位器、防止钢丝绳过卷。                                                                                                                                                          | ●      |
| <b>平衡重</b>                                                                       | 总重6.3t，有0t、6.3t两种工况。<br>选配总重9t，有0t、9t两种工况。<br>(选装9t平衡重时，不再配置6.3t平衡重)                                                                                                                                          | ●<br>○ |
| <b>吊钩</b>                                                                        | 55 t吊钩，5t吊钩。                                                                                                                                                                                                  | ●      |

产品各部件明细如上所述，具体部件明细请参照产品报价单

符号说明：

- —— 表示标准配置；
- —— 表示选装配置。

# 技术规格

## Technical specifications



|                     |                                                                                                                                                                                                                                                                                                                                                                                                   |   |
|---------------------|---------------------------------------------------------------------------------------------------------------------------------------------------------------------------------------------------------------------------------------------------------------------------------------------------------------------------------------------------------------------------------------------------|---|
| <b>Boom</b>         | 1 basic boom and 4-telescoping sections, U-shape cross section welding structure. Double cylinder plus ropes telescoping mechanism.<br>6 pulleys on boom head are standard.<br>Boom length: 11.8 m ~ 45 m.                                                                                                                                                                                        | ● |
| <b>Jib</b>          | Two-section lattice structure. Three offset angles of 0° , 15° and 30° are available. It is stowed along the side of the boom.<br>Jib length: 9.2 m~16 m.                                                                                                                                                                                                                                         | ● |
| <b>Frame</b>        | Made of high strength fine grained steel, welded torsion-resistant frame type construction with large cross-section, high load-bearing capacity.                                                                                                                                                                                                                                                  | ● |
| <b>Outrigger</b>    | 4 outriggers, H-shaped arrangement, which are controlled by electrical and hydraulic and located at both sides of chassis frame.                                                                                                                                                                                                                                                                  | ● |
| <b>Engine</b>       | Manufactured by Cummins, in line, six-cylinder water-cooled compression ignition diesel engine<br>QSB6.7:<br>rated power 194/2200(kW/(r/min))<br>max. torque 990/1500(N.m/(r/min)),<br>EU Stage IV emission standard compliant<br>B6.7:<br>rated power 209/2000(kW/(r/min))<br>max. torque 1152/1500(N.m/(r/min)),<br>EU Stage V emission standard compliant<br>Fuel tank capacity: approx. 305 L | ● |
| <b>Transmission</b> | 6WG210, automatic transmission from ZF Germany, with 6 forward and 3 reverse gears                                                                                                                                                                                                                                                                                                                | ● |
| <b>Axles</b>        | Both front and rear axles are for driving and steering, and the axles have features of great load bearing capacity                                                                                                                                                                                                                                                                                | ● |
| <b>Suspensions</b>  | Front axle is rigidly connected with frame; rear axle is equipped with swing hydraulic suspensions, which have cushioning function when driving on roads; the rear suspension cylinder may be locked to rigid state so as to meet the requirement for travel with a load suspended, increasing operation stability.                                                                               | ● |
| <b>Tires</b>        | 4 specialized off-road, large bearing capacity. Tire specifications: 29.5R25.                                                                                                                                                                                                                                                                                                                     | ● |
| <b>Steering</b>     | Front axle independent steering, tight turning radius steering, crab walk steering and rear axle independent steering modes are available. The steering angle can be self-adjusted when changing mode.                                                                                                                                                                                            | ● |
| <b>Brakes</b>       | Service brake: double-circuit hydraulic disc brake, acting on all wheels. Automatically braking and alarm are available when the pressure in braking system is too low.<br>Parking brake: spring-loaded brake, acting on front axles, hydraulic-released independent disc brake.                                                                                                                  | ● |

|                                        |                                                                                                                                                                                                                                                                                                                              |        |
|----------------------------------------|------------------------------------------------------------------------------------------------------------------------------------------------------------------------------------------------------------------------------------------------------------------------------------------------------------------------------|--------|
| <b>Hydraulic system</b>                | A dual-variable displacement pump, used for hoisting, elevating and telescoping operations, and a gear pump, used for slewing, outrigger, steering and braking operations; a load sensitive proportional multi-way change valve is used as main valve; an independent hydraulic oil radiator. Tank capacity: approx. 1120 L. | ●      |
| <b>Operating mode</b>                  | Hydraulic controlled pilot operation system is equipped with two levers controlling the main movements of the crane.                                                                                                                                                                                                         | ●      |
| <b>Electrical System</b>               | 24 V DC, two sets of 12 V battery in series.                                                                                                                                                                                                                                                                                 | ●      |
| <b>Main and auxiliary winch system</b> | The system is driven by a hydraulic motor through a planetary gear reducer, with a normally closed brake and a balance valve equipped.                                                                                                                                                                                       | ●      |
| <b>Slewing system</b>                  | Single-row four-point ball contact slewing ring, driven by a hydraulic motor through planetary gear reducer, and with a normally closed brake fitted.                                                                                                                                                                        | ●      |
| <b>Operator's cab</b>                  | Tiltable cab, with sliding door and adjustable seat equipped. It is equipped with safe glass and roof protective grille. Sun shade is available for windshield and roof window.<br>Heater and air conditioner, radio, 12 V and 24 V DC outlets are standard.                                                                 | ●      |
| <b>Safety devices</b>                  | Hydraulic balance valve, hydraulic relief valve, hydraulic double-way valve and LMI. Lowering limiter is equipped in winch to prevent rope over-releasing. Anti-two block is fitted on the boom head to prevent rope over-winding.                                                                                           | ●      |
| <b>Counterweight</b>                   | 6.3 t<br>9 t. Two counterweight configurations of 0 t and 9 t are available.<br>(If the optional 9 t slab is selected, the 6.3 t standard slab will not be supplied.)                                                                                                                                                        | ●<br>○ |
| <b>Hook Block</b>                      | 55 t hook block, 5 t hook block                                                                                                                                                                                                                                                                                              | ●      |

**Product parts list is as mentioned above. Please refer to the product quotation for specific parts.**

**Symbol explanation:**

● —it means the standard configuration;

○ —it means the optional configuration.

## 重量 Weight



| 车桥<br>Axle | 1      | 2      | 整车总重量<br>Gross vehicle weight                     |
|------------|--------|--------|---------------------------------------------------|
| t          | 24.252 | 22.503 | 46.755 (选配9t平衡重<br>Optional 9t counterweight)     |
|            | 25.298 | 18.757 | 44.055 (标配6.3t平衡重<br>Optional 6.3t counterweight) |



| 吊钩<br>Hook | 倍率<br>No. of lines | 吊钩重量<br>Weight (kg) | 备注<br>Remarks  |
|------------|--------------------|---------------------|----------------|
| 55t        | 10                 | 502                 | 单钩 Single hook |
| 5t         | 1                  | 158                 | 单钩 Single hook |

## 作业速度 Working speeds

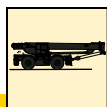

29.5 R 25



25



70%



| 作业机构<br>Drive | 作业速度<br>Working speed                                                  | 最大单绳拉力<br>Max. single line pull | 钢丝绳直径/长度<br>Rope diameter/ length |
|---------------|------------------------------------------------------------------------|---------------------------------|-----------------------------------|
| 1             | 0-150<br>m/min, 空载, 第四层<br>m/min, no load, 4th layer                   | 61kN                            | 20mm/215m                         |
| 2             | 0-100<br>m/min, 空载, 第四层<br>m/min, no load, 4th layer                   | 61kN                            | 20mm/140m                         |
| 360°          | 0-2r/min                                                               |                                 |                                   |
|               | 从-1.5° 抬起至80° 约50s<br>Approx. 50s for boom elevation from -1.5° to 80° |                                 |                                   |
|               | 从11.8m伸出至45m约90s<br>Approx. 90s for boom extension from 11.8m to 45m   |                                 |                                   |

# 平衡重 Counterweight

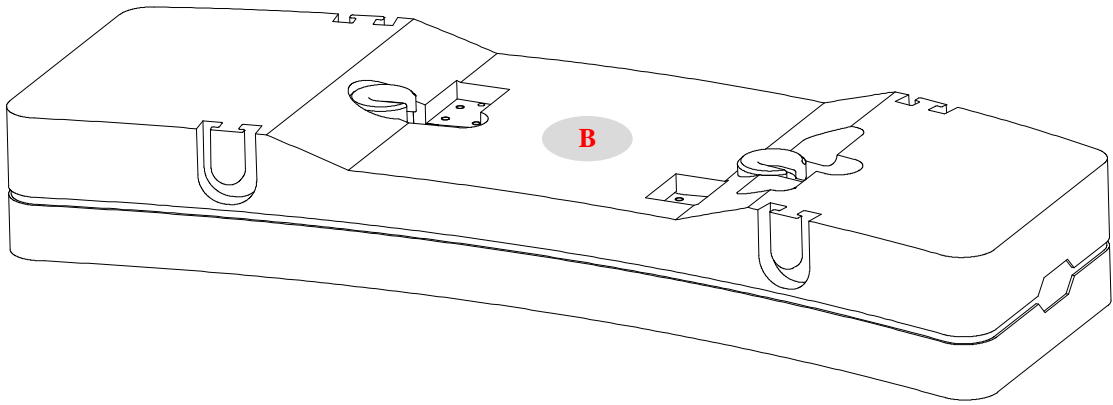
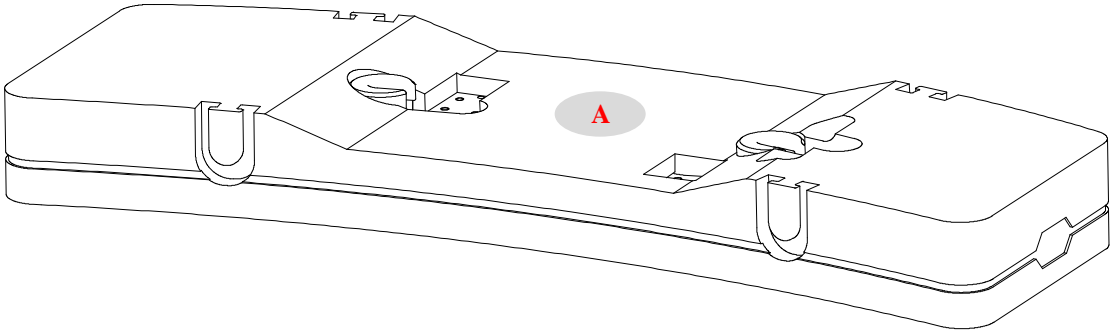

| 平衡重<br>Counterweight             | A             | B ( 选配 optional ) |
|----------------------------------|---------------|-------------------|
| 尺寸 (长×宽×高) mm<br>Size (L×W×H) mm | 3200×1250×330 | 3200×1250×450     |
| 重量 t<br>Weight t                 | 6.3           | 9                 |

| 工况模式<br>Working mode | 0t | 6.3t | 9t ( 选配 optional ) |
|----------------------|----|------|--------------------|
| 组合形式<br>Combinations | —  | A    | B                  |

## 臂架组合方案

### Boom / Jib combinations

副臂 - 9.2m  
Jib - 9.2m

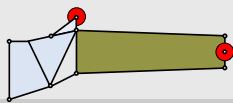

副臂 - 16m  
Jib - 16m

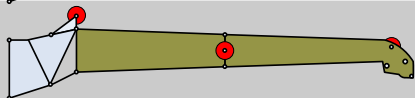

部件  
Component

结构形式  
Structure

尺寸 (长×宽×高) mm  
Size (L×W×H) mm

重量 kg  
(Weight kg)

一节、二节副臂总成+连接架  
First and second jib section  
assembly + Connecting bracket

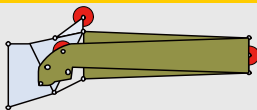

折叠 (Folded) : 9784×950×1263

932



# 臂架组合方案

## Boom / Jib combinations

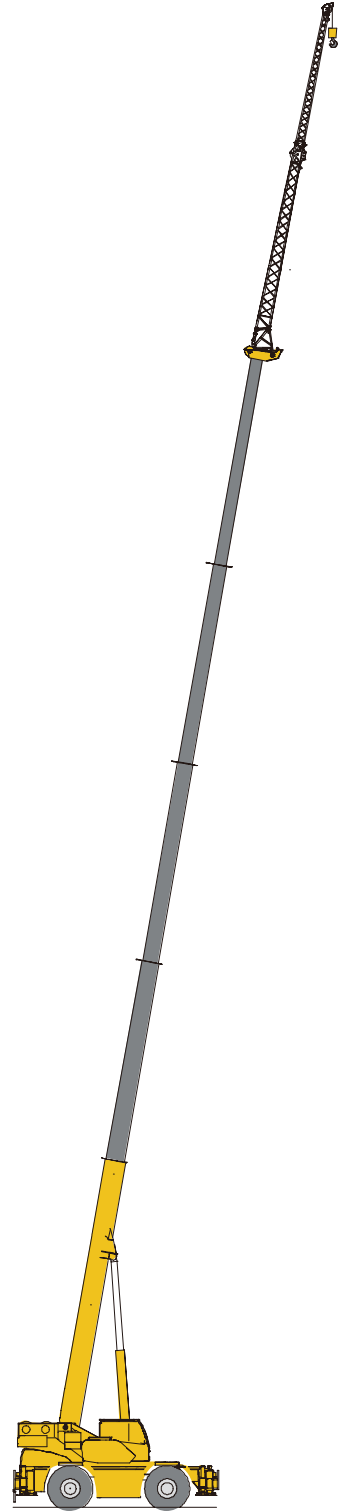
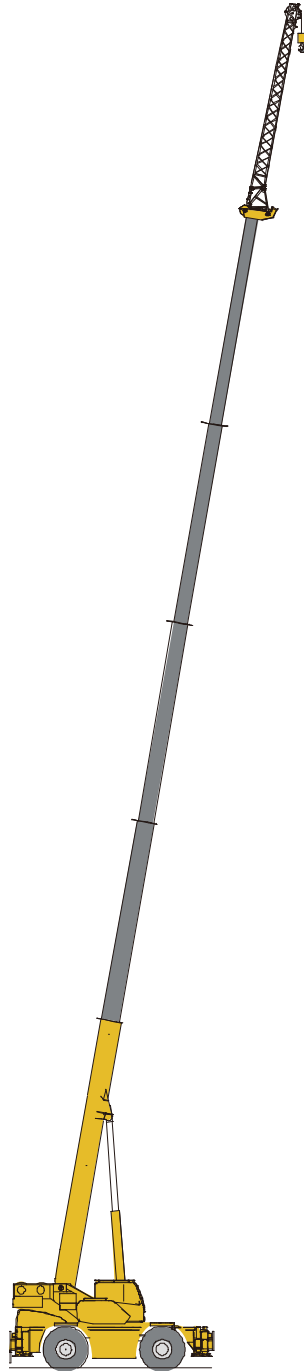
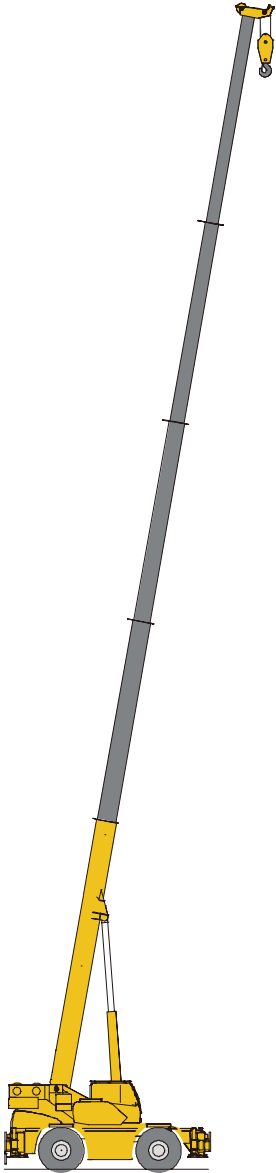

主臂  
Telescopic boom

11.8~45m

主臂 + 一节副臂  
Telescopic boom + First jib section

45m+9.2m

主臂 + 两节副臂  
Telescopic boom + First and second jib sections

45m+16 m

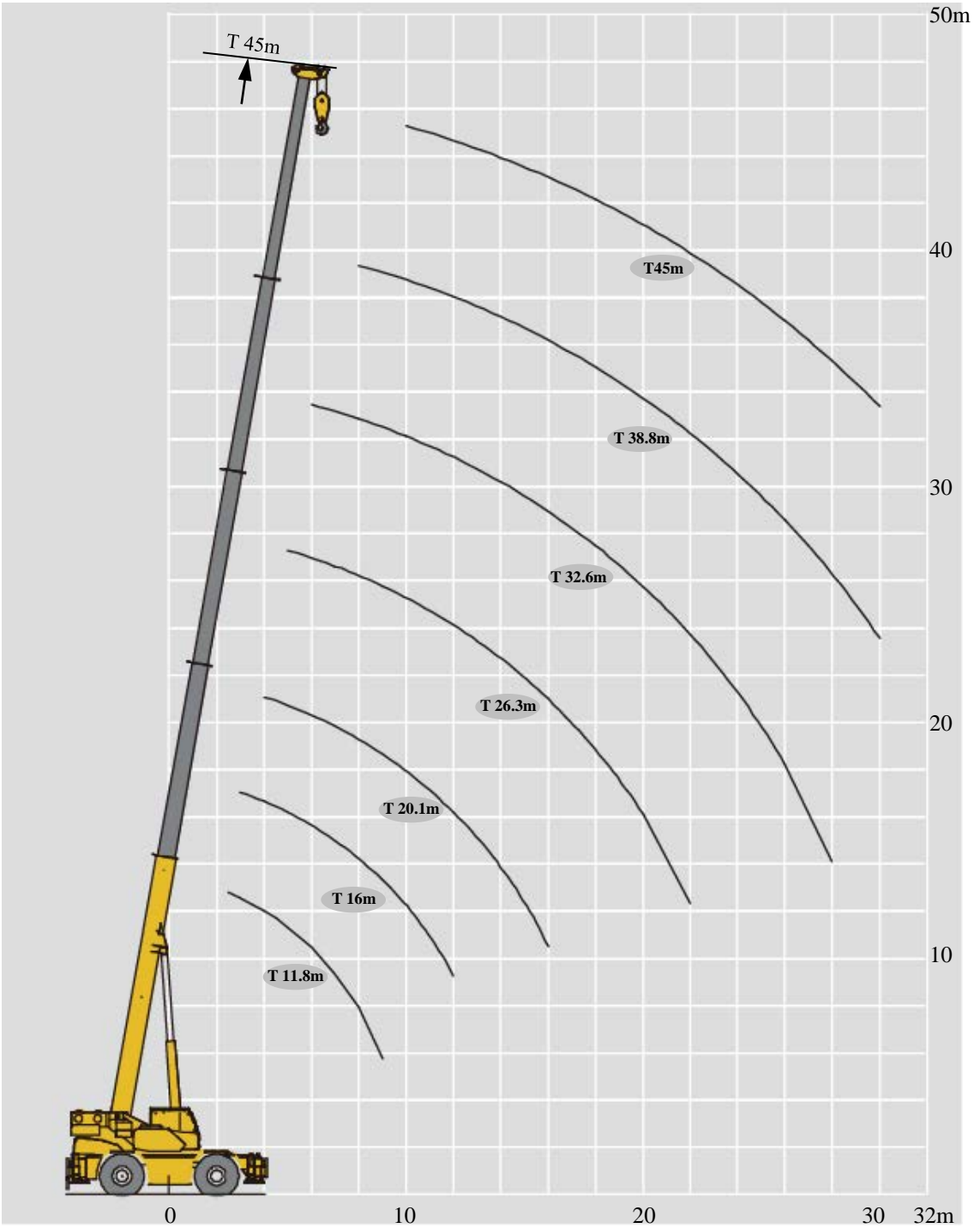

# 起重性能表

## Lifting capacities

T 11.8~45m

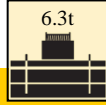

| m          | 11.8m | 16.0m | 20.1m | 26.3m | 32.6m | 38.8m | 45m  | 18.0m | 24.3m | 30.5m | 36.7m | 22.2m | 28.4m | 34.6m | 40.9m | m          |
|------------|-------|-------|-------|-------|-------|-------|------|-------|-------|-------|-------|-------|-------|-------|-------|------------|
| 2.5        | 70*   |       |       |       |       |       |      |       |       |       |       |       |       |       |       | 2.5        |
| 3          | 60    | 42.5  |       |       |       |       |      | 27.5  |       |       |       |       |       |       |       | 3          |
| 3.5        | 55    | 43.5  |       |       |       |       |      | 28.0  |       |       |       |       |       |       |       | 3.5        |
| 4          | 48    | 45    | 37    |       |       |       |      | 28.5  | 20.0  |       |       | 27.0  |       |       |       | 4          |
| 4.5        | 44    | 43    | 37    |       |       |       |      | 28.5  | 20.0  |       |       | 27.0  |       |       |       | 4.5        |
| 5          | 38    | 38    | 31    | 27    |       |       |      | 28.5  | 20.0  |       |       | 27.0  | 21.0  |       |       | 5          |
| 6          | 31    | 31    | 30    | 25.4  | 19    |       |      | 28.5  | 20.0  | 12.5  |       | 27.0  | 21.0  |       |       | 6          |
| 7          | 25    | 25    | 25    | 23.9  | 17.8  |       |      | 25.0  | 20.0  | 13.4  |       | 25.0  | 21.0  | 12.5  |       | 7          |
| 8          | 21    | 21    | 21    | 21.8  | 17.4  | 12    |      | 21.0  | 20.0  | 13.4  |       | 21    | 21.0  | 13.3  |       | 8          |
| 9          | 18.3  | 18.1  | 17.7  | 19    | 17    | 11.5  |      | 18.6  | 19.8  | 13.4  |       | 18.5  | 20.2  | 13.3  |       | 9          |
| 10         |       | 14.5  | 14.2  | 15.4  | 16.5  | 11.2  | 9.3  | 16.3  | 17    | 12.4  | 5.0   | 15.7  | 16.5  | 13.3  |       | 10         |
| 12         |       | 9.9   | 9.6   | 10.7  | 11.3  | 10.2  | 8.8  | 11.5  | 12.2  | 10.8  | 5.0   | 11    | 11.7  | 11.9  |       | 12         |
| 14         |       |       | 6.8   | 7.8   | 8.4   | 8.8   | 8.5  | 8.6   | 9.2   | 9.6   | 8.5   | 8.1   | 8.7   | 9.1   | 6.5   | 14         |
| 16         |       |       | 4.7   | 5.9   | 6.4   | 6.8   | 7.1  |       | 7.2   | 7.6   | 7.5   | 6.1   | 6.7   | 7.1   | 7.4   | 16         |
| 18         |       |       |       | 4.4   | 5     | 5.4   | 5.7  |       | 5.7   | 6.1   | 6.3   | 4.7   | 5.3   | 5.7   | 5.9   | 18         |
| 20         |       |       |       | 3.3   | 3.9   | 4.3   | 4.6  |       | 4.6   | 5     | 5.2   |       | 4.2   | 4.6   | 4.8   | 20         |
| 22         |       |       |       | 2.5   | 3.1   | 3.4   | 3.7  |       |       | 4.1   | 4.3   |       | 3.3   | 3.7   | 4     | 22         |
| 24         |       |       |       |       | 2.2   | 2.6   | 3    |       |       | 3.4   | 3.6   |       | 2.5   | 3     | 3.3   | 24         |
| 26         |       |       |       |       | 1.6   | 2     | 2.3  |       |       | 2.9   | 3     |       |       | 2.3   | 2.6   | 26         |
| 28         |       |       |       |       | 1.1   | 1.5   | 1.8  |       |       |       | 2.5   |       |       | 1.8   | 2.1   | 28         |
| 30         |       |       |       |       |       | 1.1   | 1.4  |       |       |       | 1.9   |       |       | 1.3   | 1.6   | 30         |
| 二节臂<br>2nd | 0     | 50%   | 100%  | 100%  | 100%  | 100%  | 100% | 0%    | 0%    | 0%    | 0%    | 50%   | 50%   | 50%   | 50%   | 二节臂<br>2nd |
| 三节臂<br>3rd | 0     | 0     | 0     | 25%   | 50%   | 75%   | 100% | 25%   | 50%   | 75%   | 100%  | 25%   | 50%   | 75%   | 100%  | 三节臂<br>3rd |
| 四节臂<br>4th | 0     | 0     | 0     | 25%   | 50%   | 75%   | 100% | 25%   | 50%   | 75%   | 100%  | 25%   | 50%   | 75%   | 100%  | 四节臂<br>4th |
| 五节臂<br>5th | 0     | 0     | 0     | 25%   | 50%   | 75%   | 100% | 25%   | 50%   | 75%   | 100%  | 25%   | 50%   | 75%   | 100%  | 五节臂<br>5th |

\*70t需使用臂端单滑轮与主臂滑轮组合，13倍率。

The lifting load with a \* followed is available only when the boom sheave block is used together with the single top, with 13 parts of line.

# 起重性能表

## Lifting capacities

T 11.8~45m

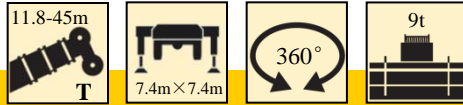

| m          | 11.8m | 16.0m | 20.1m | 26.3m | 32.6m | 38.8m | 45m  | 18.0m | 24.3m | 30.5m | 36.7m | 22.2m | 28.4m | 34.6m | 40.9m | m          |
|------------|-------|-------|-------|-------|-------|-------|------|-------|-------|-------|-------|-------|-------|-------|-------|------------|
| 2.5        | 70*   |       |       |       |       |       |      |       |       |       |       |       |       |       |       | 2.5        |
| 3          | 60    | 42.5  |       |       |       |       |      | 27.5  |       |       |       |       |       |       |       | 3          |
| 3.5        | 55    | 43.5  |       |       |       |       |      | 28.0  |       |       |       |       |       |       |       | 3.5        |
| 4          | 50    | 45    | 37    |       |       |       |      | 28.5  | 20.0  |       |       | 27.0  |       |       |       | 4          |
| 4.5        | 46    | 43    | 37    |       |       |       |      | 28.5  | 20.0  |       |       | 27.0  |       |       |       | 4.5        |
| 5          | 40    | 40    | 33.5  | 27    |       |       |      | 28.5  | 20.0  |       |       | 27.0  | 21.0  |       |       | 5          |
| 6          | 33.5  | 33.3  | 31.5  | 25.4  | 19    |       |      | 28.5  | 20.0  | 12.5  |       | 27.0  | 21.0  |       |       | 6          |
| 7          | 27.5  | 27.5  | 27.4  | 23.9  | 17.8  |       |      | 27.5  | 20.0  | 13.4  |       | 27.0  | 21.0  | 12.5  |       | 7          |
| 8          | 23.5  | 23.5  | 23    | 21.8  | 17.4  | 12    |      | 23.5  | 20.0  | 13.4  |       | 24.0  | 21.0  | 13.3  |       | 8          |
| 9          | 20    | 20    | 20    | 19    | 17    | 11.5  |      | 20.0  | 19.8  | 13.4  |       | 20.0  | 20.7  | 13.3  |       | 9          |
| 10         |       | 16.5  | 16.2  | 17    | 16.5  | 11.2  | 9.3  | 18.3  | 18.5  | 12.4  | 5.0   | 17.7  | 16.9  | 13.3  |       | 10         |
| 12         |       | 11.4  | 11.1  | 12.2  | 13.2  | 10.2  | 8.8  | 13    | 13.7  | 10.8  | 5.0   | 12.5  | 12    | 11.9  |       | 12         |
| 14         |       |       | 8     | 9.1   | 9.7   | 9.7   | 8.5  | 9.8   | 10.4  | 9.6   | 8.5   | 9.3   | 9     | 10.4  | 6.5   | 14         |
| 16         |       |       | 5.9   | 6.9   | 7.5   | 7.9   | 7.8  |       | 8.2   | 8.6   | 7.5   | 7.2   | 7     | 8.2   | 8.0   | 16         |
| 18         |       |       |       | 5.3   | 5.9   | 6.3   | 6.6  |       | 6.6   | 7     | 6.7   | 5.6   | 5.5   | 6.6   | 6.8   | 18         |
| 20         |       |       |       | 4.2   | 4.7   | 5.1   | 5.4  |       | 5.4   | 5.8   | 6.0   |       | 4.3   | 5.4   | 5.6   | 20         |
| 22         |       |       |       | 3.2   | 3.8   | 4.1   | 4.4  |       |       | 4.8   | 5     |       | 3.5   | 4.4   | 4.7   | 22         |
| 24         |       |       |       |       | 3     | 3.4   | 3.6  |       |       | 4.1   | 4.2   |       | 2.8   | 3.7   | 3.9   | 24         |
| 26         |       |       |       |       | 2.2   | 2.8   | 3    |       |       | 3.4   | 3.6   |       |       | 3     | 3.3   | 26         |
| 28         |       |       |       |       | 1.7   | 2.2   | 2.5  |       |       |       | 3.1   |       |       | 2.5   | 2.7   | 28         |
| 30         |       |       |       |       |       | 1.7   | 2    |       |       |       | 2.6   |       |       | 2.1   | 2.2   | 30         |
| 32         |       |       |       |       |       | 1.3   | 1.5  |       |       |       |       |       |       |       | 1.9   | 32         |
| 二节臂<br>2nd | 0     | 50%   | 100%  | 100%  | 100%  | 100%  | 100% | 0%    | 0%    | 0%    | 0%    | 50%   | 50%   | 50%   | 50%   | 二节臂<br>2nd |
| 三节臂<br>3rd | 0     | 0     | 0     | 25%   | 50%   | 75%   | 100% | 25%   | 50%   | 75%   | 100%  | 25%   | 50%   | 75%   | 100%  | 三节臂<br>3rd |
| 四节臂<br>4th | 0     | 0     | 0     | 25%   | 50%   | 75%   | 100% | 25%   | 50%   | 75%   | 100%  | 25%   | 50%   | 75%   | 100%  | 四节臂<br>4th |
| 五节臂<br>5th | 0     | 0     | 0     | 25%   | 50%   | 75%   | 100% | 25%   | 50%   | 75%   | 100%  | 25%   | 50%   | 75%   | 100%  | 五节臂<br>5th |

\*70t需使用臂端单滑轮与主臂滑轮组合，13倍率。

The lifting load with a \* followed is available only when the boom sheave block is used together with the single top, with 13 parts of line.

# 起升高度曲线图 Lifting heights

副臂  
Jib

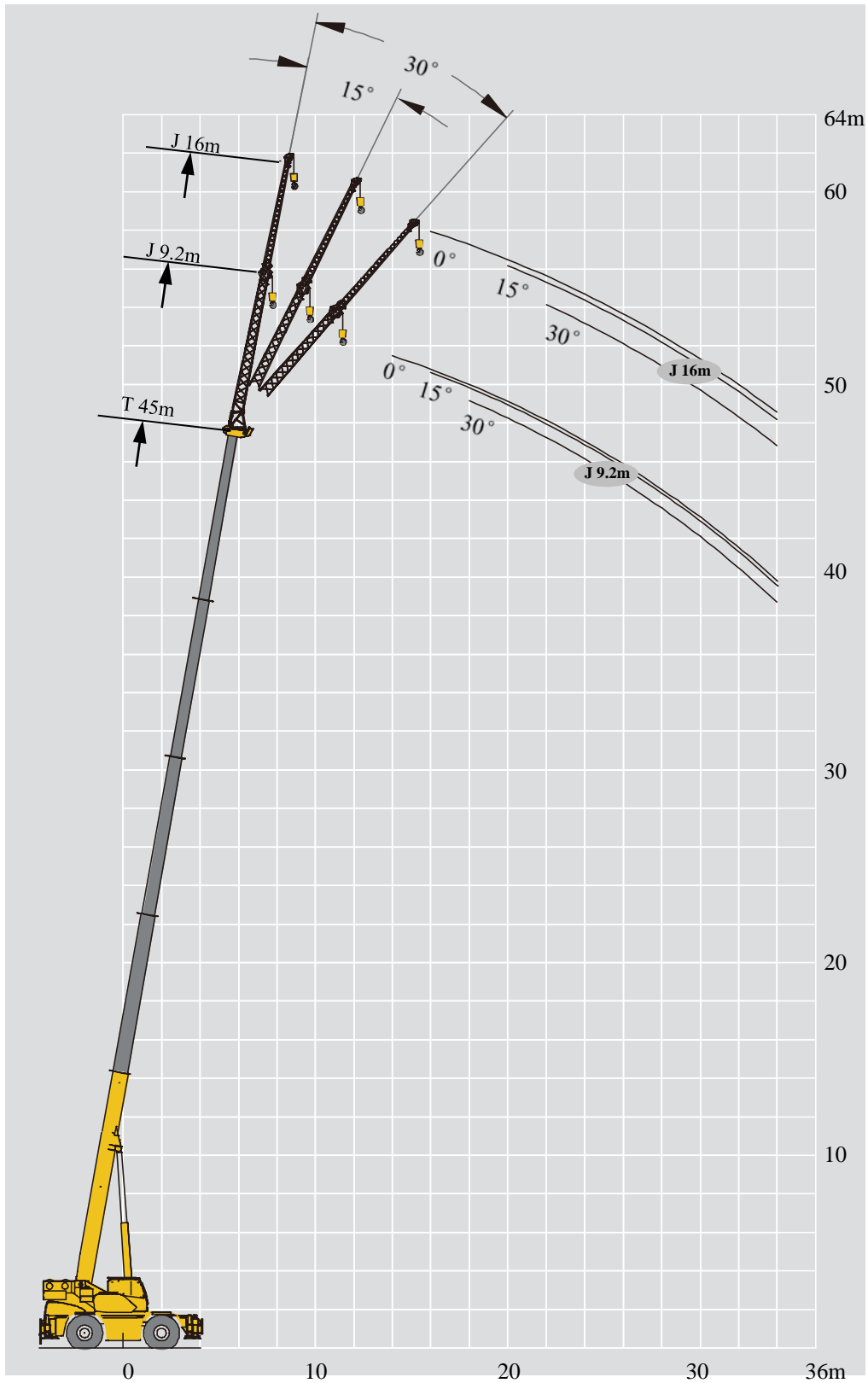

# 起重性能表

## Lifting capacities

J 9.2-16m

| m  | 45 m + 9.2m |     |     | m  |
|----|-------------|-----|-----|----|
|    | 0°          | 15° | 30° |    |
| 14 | 4.8         |     |     | 14 |
| 16 | 4.7         | 3.1 |     | 16 |
| 18 | 4.5         | 3   | 2.4 | 18 |
| 20 | 3.9         | 3   | 2.3 | 20 |
| 22 | 3.6         | 2.7 | 2.2 | 22 |
| 24 | 2.8         | 2.6 | 2.1 | 24 |
| 26 | 2.2         | 2.5 | 2   | 26 |
| 28 | 1.7         | 1.9 | 1.9 | 28 |
| 30 | 1.3         | 1.5 | 1.7 | 30 |

| m  | 45 m + 16m |     |     | m  |
|----|------------|-----|-----|----|
|    | 0°         | 15° | 30° |    |
| 16 | 2.9        |     |     | 16 |
| 18 | 2.8        |     |     | 18 |
| 20 | 2.6        | 1.9 |     | 20 |
| 22 | 2.5        | 1.8 | 1.3 | 22 |
| 24 | 2.3        | 1.6 | 1.3 | 24 |
| 26 | 2.1        | 1.5 | 1.2 | 26 |
| 28 | 1.9        | 1.4 | 1.2 | 28 |
| 30 | 1.7        | 1.3 | 1.2 | 30 |

# 起重性能表

## Lifting capacities

J 9.2-16m

| m  | 45 m+9.2m |     |     | m  |
|----|-----------|-----|-----|----|
|    | 0°        | 15° | 30° |    |
| 14 | 4.8       |     |     | 14 |
| 16 | 4.7       | 3.1 |     | 16 |
| 18 | 4.5       | 3   | 2.4 | 18 |
| 20 | 3.9       | 3   | 2.3 | 20 |
| 22 | 3.8       | 2.7 | 2.2 | 22 |
| 24 | 3.5       | 2.6 | 2.1 | 24 |
| 26 | 2.8       | 2.5 | 2   | 26 |
| 28 | 2.2       | 2.3 | 1.9 | 28 |
| 30 | 1.8       | 2   | 1.8 | 30 |
| 32 | 1.4       | 1.6 | 1.7 | 32 |
| 34 | 1         | 1.2 | 1.3 | 34 |



| m  | 45 m+16m |     |     | m  |
|----|----------|-----|-----|----|
|    | 0°       | 15° | 30° |    |
| 16 | 2.9      |     |     | 16 |
| 18 | 2.8      |     |     | 18 |
| 20 | 2.6      | 1.9 |     | 20 |
| 22 | 2.5      | 1.8 | 1.3 | 22 |
| 24 | 2.3      | 1.6 | 1.3 | 24 |
| 26 | 2.1      | 1.5 | 1.2 | 26 |
| 28 | 1.9      | 1.4 | 1.2 | 28 |
| 30 | 1.8      | 1.3 | 1.2 | 30 |
| 32 | 1.7      | 1.2 | 1.1 | 32 |
| 34 | 1.4      | 1.2 | 1.1 | 34 |

## 符号标识

### Description of symbols

#### 常规标识

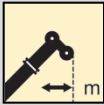
##### Symbol glossary

|                                                                                    |                          |                                                                                     |                                |
|------------------------------------------------------------------------------------|--------------------------|-------------------------------------------------------------------------------------|--------------------------------|
|    | 支腿<br>Outriggers         |    | 车桥<br>Axle                     |
|    | 工作幅度<br>Radius           |    | 行驶速度<br>Driving speed          |
|    | 吊臂仰角<br>Boom angle       |    | 爬坡能力<br>Grade ability          |
|    | 吊臂长度<br>Boom length      |    | 轮胎<br>Tires                    |
|   | 吊钩<br>Hook block         |   | 平衡重<br>Counterweight           |
|  | 360°全回转<br>360° rotation |  | 上车<br>Superstructure           |
|  | 卷扬<br>Winch              |  | 越野轮胎起重机<br>Rough terrain crane |

#### 起重作业标识

##### Crane specific symbols

|                                                                                    |            |                                                                                     |           |
|------------------------------------------------------------------------------------|------------|-------------------------------------------------------------------------------------|-----------|
|  | 主臂<br>Boom |  | 副臂<br>Jib |
|------------------------------------------------------------------------------------|------------|-------------------------------------------------------------------------------------|-----------|



# 主要技术参数表

## Table of main technical parameters

| 类别<br>Category     | 项目<br>Item                                               | 单位<br>Unit  | 参数<br>Parameter                         |                                     | 允差范围<br>Allowance |     |
|--------------------|----------------------------------------------------------|-------------|-----------------------------------------|-------------------------------------|-------------------|-----|
| 尺寸参数<br>Dimensions | 外形尺寸 (长×宽×高)<br>Outline size<br>(length×width×height)    | mm          | 14354×3290×3750                         |                                     | ±1%               |     |
|                    | 轴距<br>Wheel base                                         | mm          | 4000                                    |                                     | ±1%               |     |
|                    | 轮距 (前/后)<br>Track (Front/ Rear)                          | mm          | 2520/2520                               |                                     | ±1%               |     |
|                    | 前悬/后悬<br>Front/ Rear overhang                            | mm          | 2200/2400                               |                                     | ±1%               |     |
|                    | 前伸/后伸<br>Front/ Rear extension                           | mm          | 5754/0                                  |                                     | ±1%               |     |
| 重量参数<br>Weight     | 整车总重量<br>Gross vehicle weight                            | kg          | 44055 (6.3t平衡重)<br>(6.3t counterweight) | 46755 (9t平衡重)<br>(9t counterweight) | ±3%               |     |
|                    | 轴荷<br>Axle load                                          | 一轴 1st axle | kg                                      | 25298                               | 24252             | ±3% |
|                    |                                                          | 二轴 2nd axle | kg                                      | 18757                               | 22503             | ±3% |
| 动力参数<br>Power      | 发动机型号<br>Engine model                                    | —           | QSB6.7                                  | B6.7                                | —                 |     |
|                    | 额定功率/转速<br>Engine rated power/rpm                        | kW/(r/min)  | 194/2000                                | 209/2000                            | —                 |     |
|                    | 最大输出扭矩/转速<br>Engine rated torque/rpm                     | N.m/(r/min) | 990/1500                                | 1152/1500                           | —                 |     |
| 行驶参数<br>Travel     | 最高车速<br>Max. travel speed                                | km/h        | ≤25                                     |                                     | —                 |     |
|                    | 最低稳定车速<br>Min. travel speed                              | km/h        | ≤1.8                                    |                                     | —                 |     |
|                    | 最小转弯直径<br>Min. turning diameter                          | m           | ≤13                                     |                                     | —                 |     |
|                    | 最小离地间隙<br>Min. ground clearance                          | mm          | 475                                     |                                     | ±1%               |     |
|                    | 接近角<br>Approach angle                                    | °           | 23                                      |                                     | ±1°               |     |
|                    | 离去角<br>Departure angle                                   | °           | 21                                      |                                     | ±1°               |     |
|                    | 制动距离 (制动初速度为<br>24km/h)<br>Braking distance (at 24 km/h) | m           | ≤9                                      |                                     | —                 |     |
|                    | 最大爬坡能力<br>Max. grade ability                             | %           | ≥70                                     |                                     | —                 |     |

# 主要技术参数表

## Table of main technical parameters

| 类别<br>Category                                                       | 项目<br>Item                                        |                                      | 单位<br>Unit   | 参数<br>Parameter | 允差范围<br>Allowance |   |
|----------------------------------------------------------------------|---------------------------------------------------|--------------------------------------|--------------|-----------------|-------------------|---|
| 主要性能参数<br>Main performance                                           | 最大额定总起重量 Max. total rated lifting capacity        |                                      | t            | 70              | ±5%               |   |
|                                                                      | 最小额定工作幅度 Min. rated working radius                |                                      | m            | 2.5             | ±1%               |   |
|                                                                      | 转台尾部回转半径<br>Turning radius at turntable tail      | 平衡重处 Counterweight                   | mm           | 4200            | ±1%               |   |
|                                                                      | 最大起重力矩<br>Max. load moment                        | 基本臂<br>Base boom                     | kN.m         | 2028.6          | ±5%               |   |
|                                                                      |                                                   | 最长主臂<br>Fully-extended boom          | kN.m         | 1223            | ±5%               |   |
|                                                                      | 支腿跨距<br>Outrigger span                            | 纵向 Longitudinal                      | m            | 7.4             | ±1%               |   |
|                                                                      |                                                   | 横向 Lateral                           | m            | 7.4             | ±1%               |   |
|                                                                      | 起升高度<br>Hoist height                              | 基本臂<br>Base boom                     | m            | 12.8            | ±1%               |   |
|                                                                      |                                                   | 最长主臂<br>Fully-extended boom          | m            | 45.3            | ±1%               |   |
|                                                                      |                                                   | 最长主臂+副臂<br>Fully-extended boom + Jib | m            | 57.9            | ±1%               |   |
|                                                                      | 起重臂长度<br>Boom length                              | 基本臂<br>Base boom                     | m            | 11.8            | ±1%               |   |
|                                                                      |                                                   | 最长主臂<br>Fully-extended boom          | m            | 45              | ±1%               |   |
|                                                                      |                                                   | 最长主臂+副臂<br>Fully-extended boom + Jib | m            | 61              | ±1%               |   |
| 副臂安装角 Jib offset angle                                               |                                                   |                                      | °            | 0°、15°、30°      | —                 |   |
| 工作速度参数<br>Working speed                                              | 起重臂起臂时间 Boom raising time                         |                                      | s            | ≤50             | —                 |   |
|                                                                      | 起重臂全伸时间 Boom fully extending time                 |                                      | s            | ≤90             | —                 |   |
|                                                                      | 最大回转速度 Max. slewing speed                         |                                      | r/min        | ≥2              | —                 |   |
|                                                                      | 支腿收放时间<br>Outrigger extending and retracting time | 水平支腿<br>Outrigger beam               | 收 Retracting | s               | ≤20               | — |
|                                                                      |                                                   |                                      | 放 Extending  | s               | ≤35               | — |
|                                                                      |                                                   | 垂直支腿<br>Outrigger jack               | 收 Retracting | s               | ≤30               | — |
|                                                                      |                                                   |                                      | 放 Extending  | s               | ≤35               | — |
| 起升速度 (单绳,第四层,空载)<br>Hoisting speed (single line, 4th layer, no load) | 主起升机构 Main winch                                  | m/min                                | ≥150         | —               |                   |   |
|                                                                      | 副起升机构 Auxiliary winch                             | m/min                                | ≥100         | —               |                   |   |

## 注意事项

### Notes

1. 表中额定总起重量值，是在平整的坚固地面上本起重机能够保证的最大总起重量，包括吊钩和吊具的重量，所以为了估算重物重量，必须减去上述的装置重量。
2. 表中的工作幅度为起吊重物离地时起重物到起重机回转轴线的水平距离，是包括起重臂变形量在内的实际值，因而起吊前应考虑起重臂变形量。
3. 只允许在5级(瞬时风速14.1m/s，风压125N/m<sup>2</sup>)风以下进行作业。
4. 吊重前操作者必须对物体的重量和工作范围了解后选择合适的作业工况，严禁超出表中的数值。幅度及臂长在相邻两个数值之间时，应依据两个数值中较小值确定起重作业。
5. 应按主臂仰角范围作业，即使是空载，也不应使主臂仰角处于范围外，谨防整机倾翻。
6. 表中的主臂长度应要按照每节臂的伸缩要求进行伸出。

1. The total rated loads given in the rated load charts are the maximum lifting capacity when the crane is set up on firm and level ground, which includes the weight of the hook block and slings. The weight of above-mentioned devices should be deducted from the rated lifting load.
2. The working radius shown in the rated load charts is the radius when the load is lifted off the ground, and it is the actual value including loaded boom deflection. Take boom deflection into consideration before beginning a lifting operation.
3. A lifting operation is permissible only when the wind force is below grade 5 (instantaneous wind speed is 14.1 m/s, wind pressure is 125 N/m<sup>2</sup>).
4. Before beginning lifting operation, the operator should know the weight of the load to be lifted and its working range, and then select proper working conditions. Never operate the crane beyond the limit shown in the chart. Use the lower value from the chart when the boom length or working radius is between the range of values.
5. Observe the boom angle limit. Never operate the crane with the boom angle beyond the recommended limit even if a load is not being carried. Otherwise, the crane will tip.
6. The boom should be extended according to the telescoping code shown by digits, which means the percentage of boom sections extended.



地址：江苏省徐州市经济技术开发区高新路68号

Add : No. 68 Gaoxin Road, Economic and Technological  
Development Zone, Xuzhou, Jiangsu, China

电话(Tel) : +86-516-83462242/83462350

质量监督电话(Quality Inquiry Tel) : +86-516-87888268

备件电话(Spare Parts Tel) : +86-516-83461542

邮编(Post Code) : 221004

网址(Web) : [www.xcmg.com/qizhongji](http://www.xcmg.com/qizhongji)

**服务热线 Service Tel**

**400-110-9999**

**400-001-5678**



本印刷品不属于合同。出于产品不断改进的需要，我们保留对产品型号、参数、配置进行变更的权利，恕不另行通知。图片仅供参考，具体产品以实物为准。图片中产品可能并非标准配置，部分部件可能需要另行购置。办理牌照和上路行驶需遵守当地法规。

This print does not belong to the contract. We reserve the right to modify the design (such as product model, parameters and configuration) without notice for improvement. The pictures are just for reference. The product in the picture may not be standard configuration. Some parts need to be purchased separately. Conform to the local laws for license application and road traveling.